

TON

SON

TURE

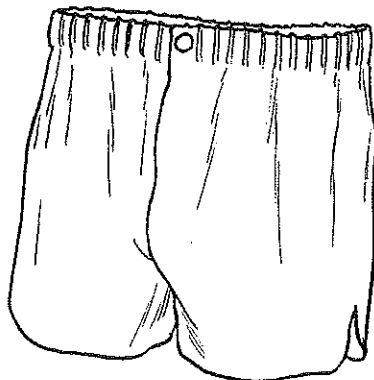
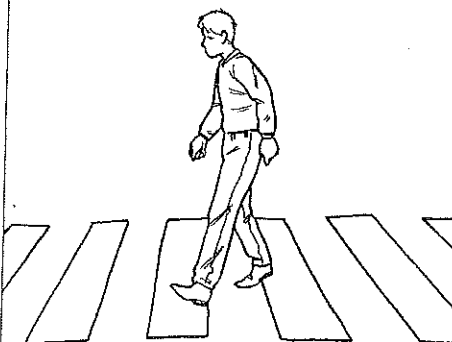
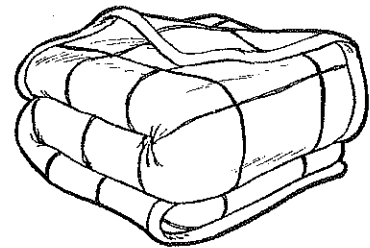
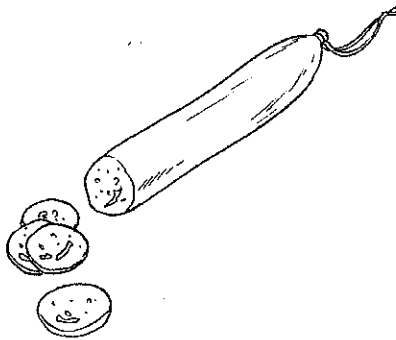
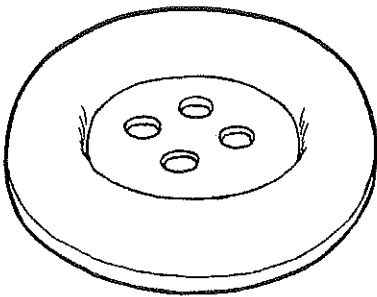
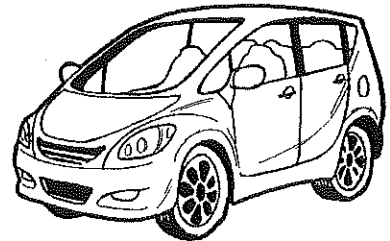
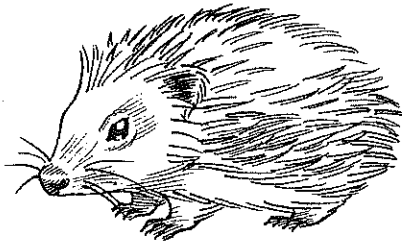
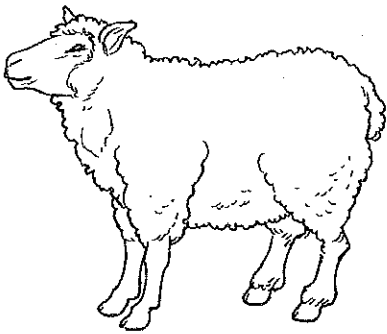
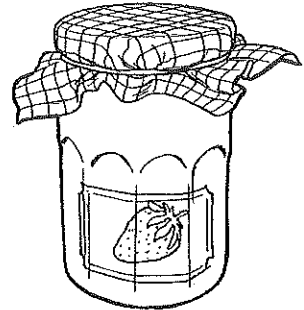
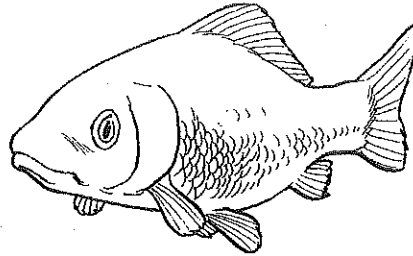
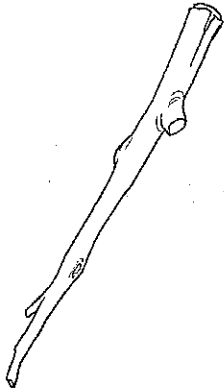

bâton · mouton · bouton · piéton

poisson · hérisson · saucisson · caleçon

confiture · voiture · couverture · peinture

DO

LON

TO

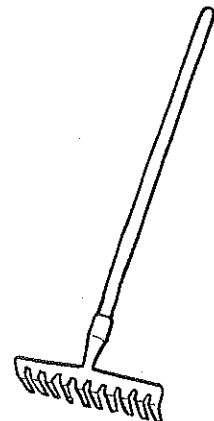
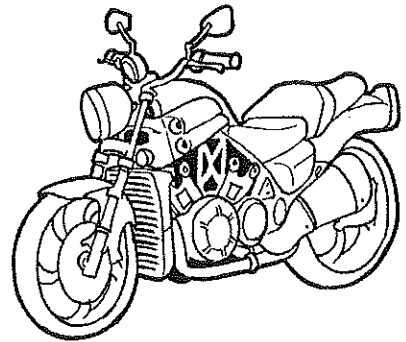
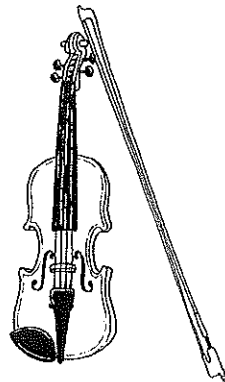
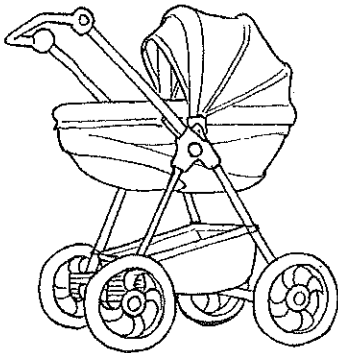
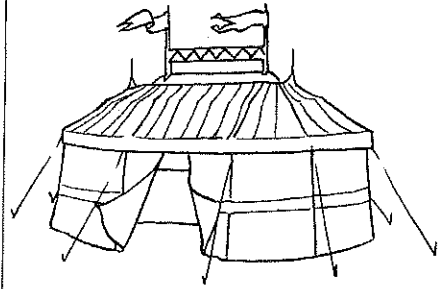
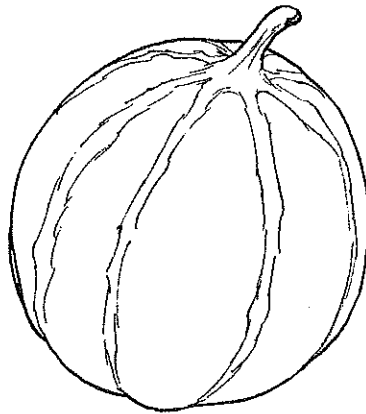
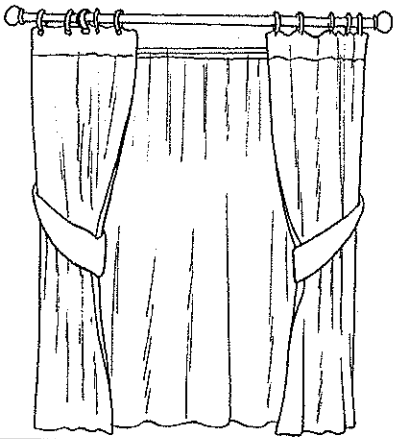
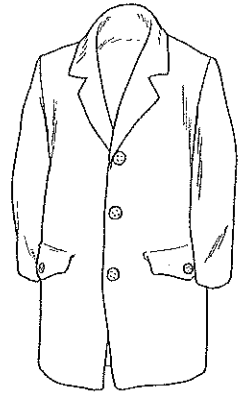
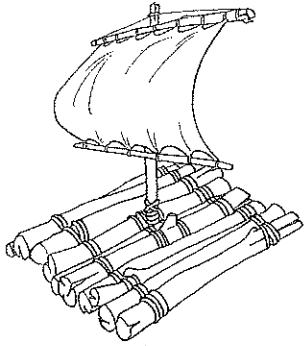

radeau - rideau - landau - judo

ballon - melon - violon - talon

manteau - chapiteau - moto - râteau